

2x5 TON PROJE

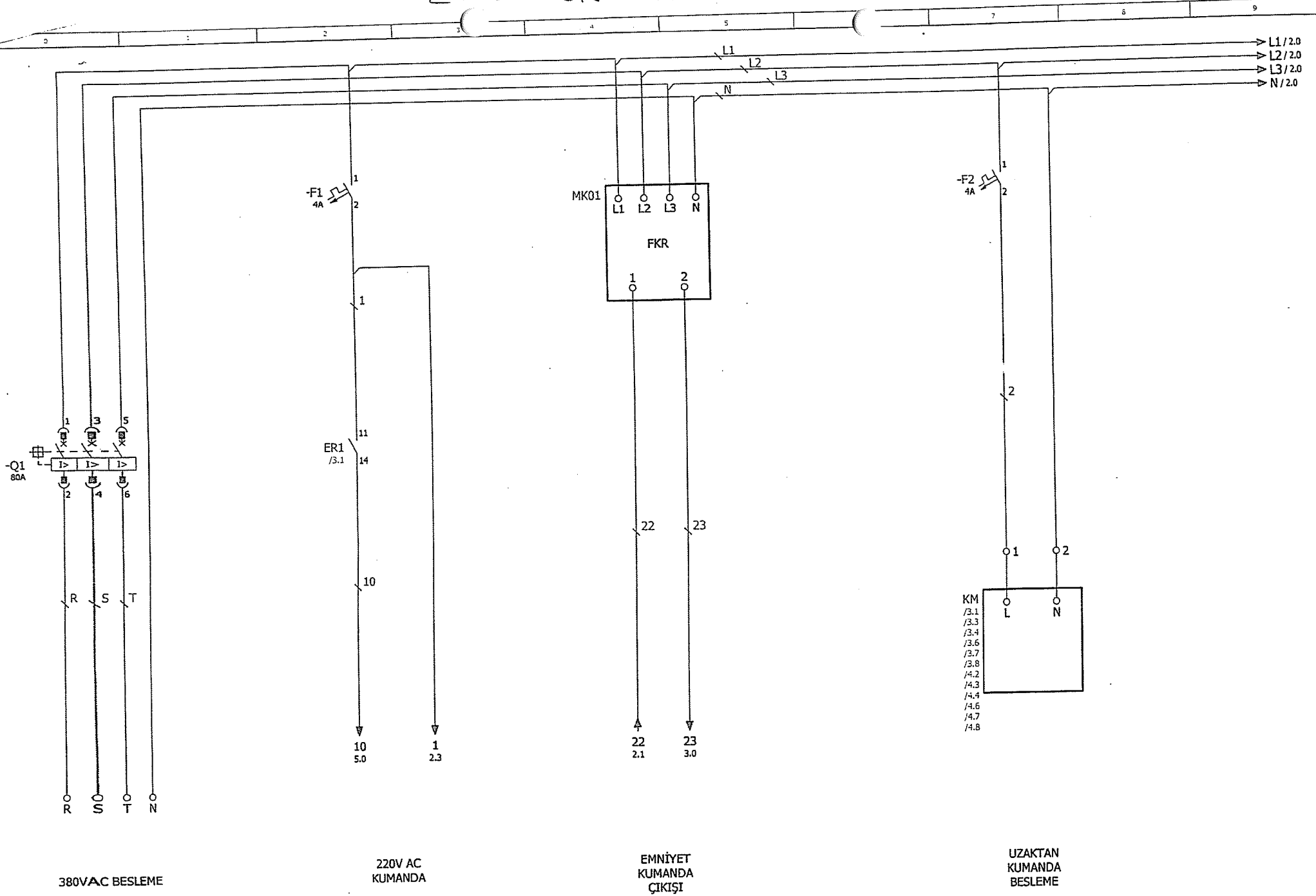

380VAC BESLEME

220V AC
KUMANDA

EMNİYET
KUMANDA
ÇIKIŞI

UZAKTAN
KUMANDA
BESLEME

Date	29.03.2023
Ed	IDRİS
Appr	

380VAC BESLEME
220VAC KUMANDA

=	
+	
Page	1/1
Page	1/1

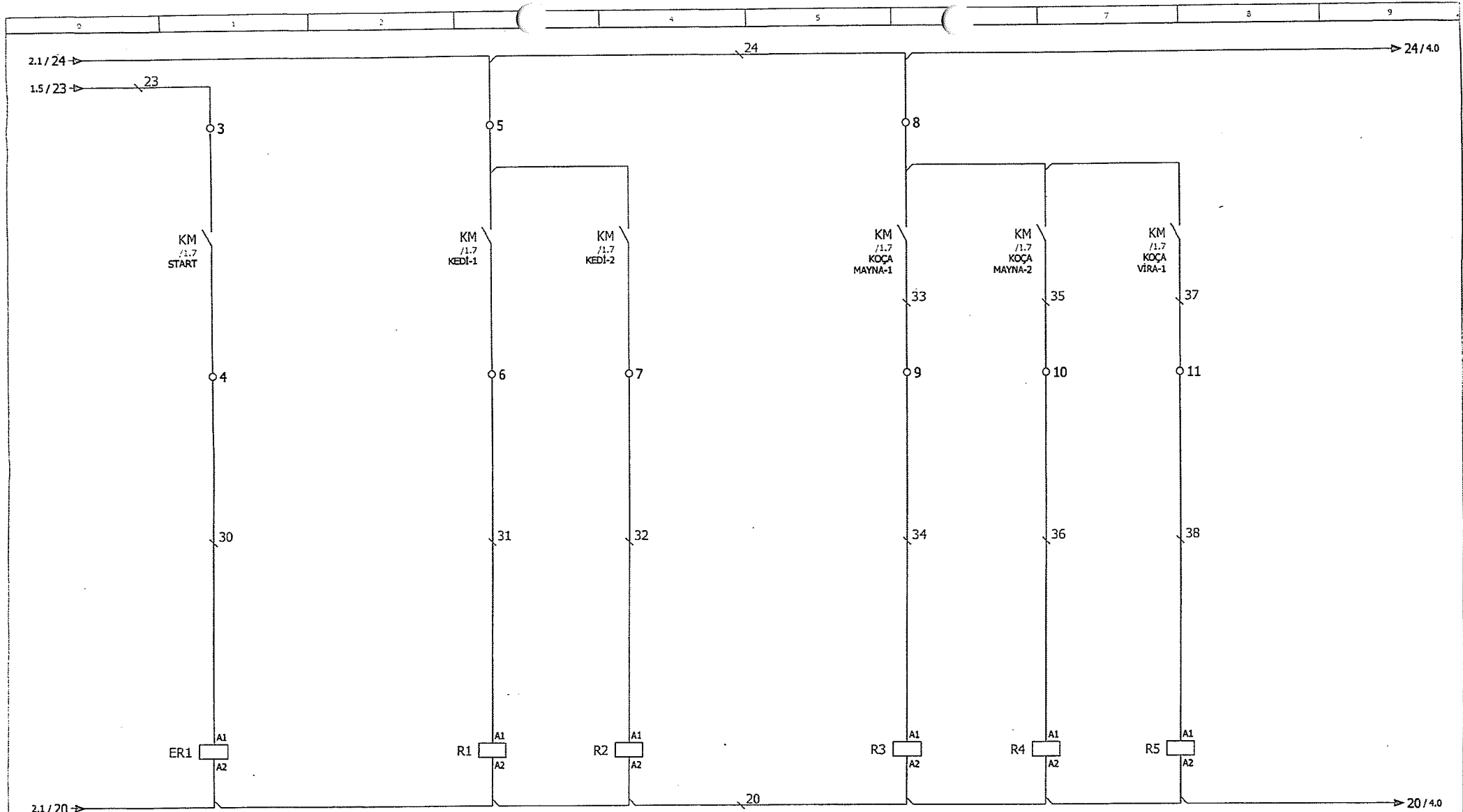

11 ~ 14 /1.2
21 ~ 24 /2.1

11 ~ 14 /5.2
21 ~ 24 /6.2

11 ~ 14 /7.2
21 ~ 24 /8.2

11 ~ 14 /5.3
21 ~ 24 /7.3

11 ~ 14 /5.4
21 ~ 24 /7.4

11 ~ 14 /5.4
21 ~ 24 /7.4

EMNİYET ROLESİ

SEÇİM ROLESİ KEDİ - 1

SEÇİM ROLESİ KEDİ - 2

KOÇA MAYNA ROLESİ

KOÇA VİRA ROLESİ

KOÇA 2. HIZ ROLESİ

3.9/24

24

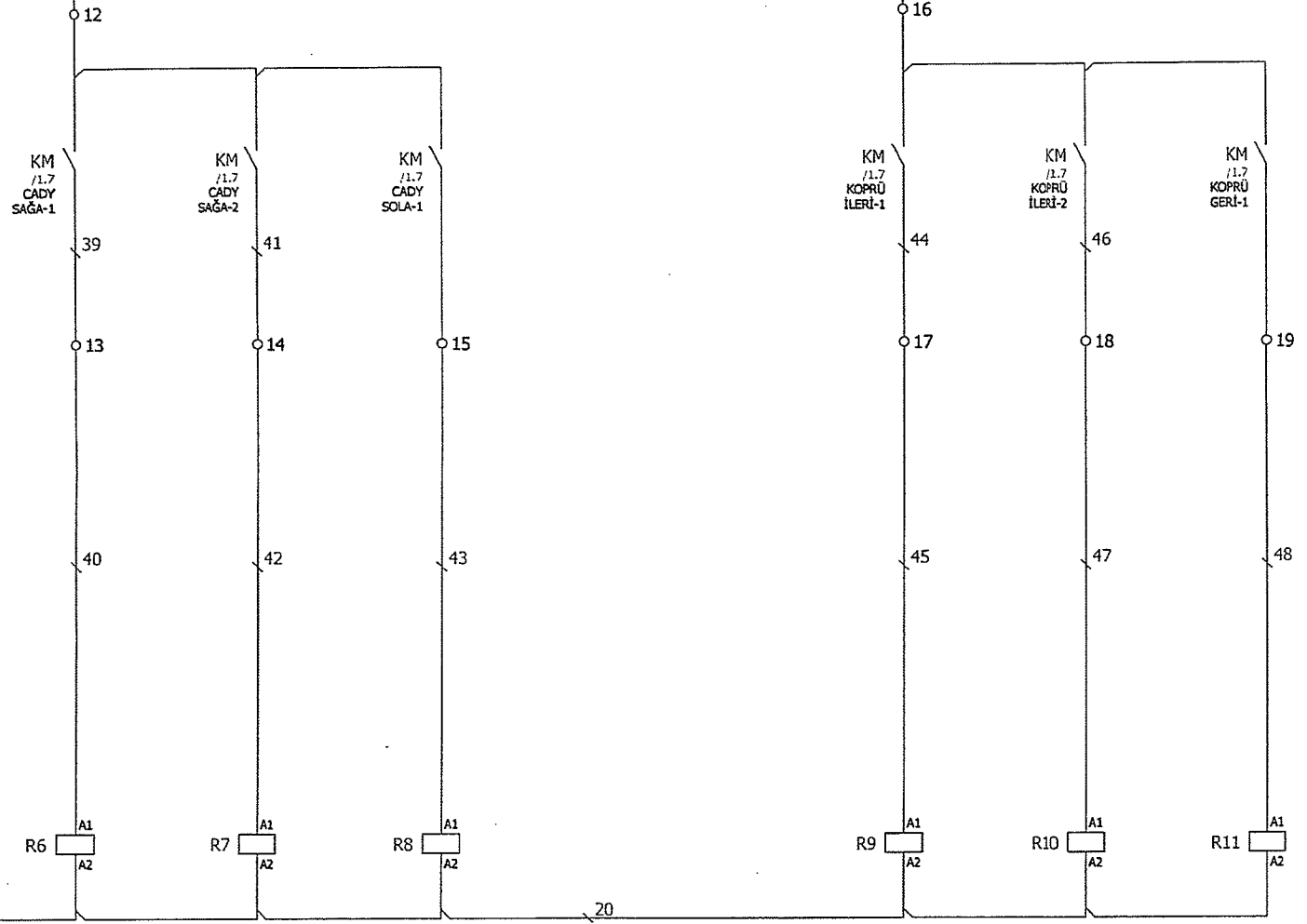

11 - 14 / 6.3
21 - 24 / 8.3

11 - 14 / 6.4
21 - 24 / 8.4

11 - 14 / 6.4
21 - 24 / 8.4

11 - 14 / 9.3

11 - 14 / 9.4

11 - 14 / 9.5

CADY K.MÜRSEL
ROLESİ

CADY YALOVA
ROLESİ

CADY 2. HIZ
ROLESİ

KÖPRÜ KARA
ROLESİ

KÖPRÜ DENİZ
ROLESİ

KÖPRÜ 2. HIZ
ROLESİ

3

5

Date	29.03.2023				
Ed	IDRİS				
Appr					
Modification	Date	Name	Original	Replacement of	Replaced by

UZAKTAN KUMANDA KONTROL
ROLELERİ

=	
+	
Page	4
Page	4/9

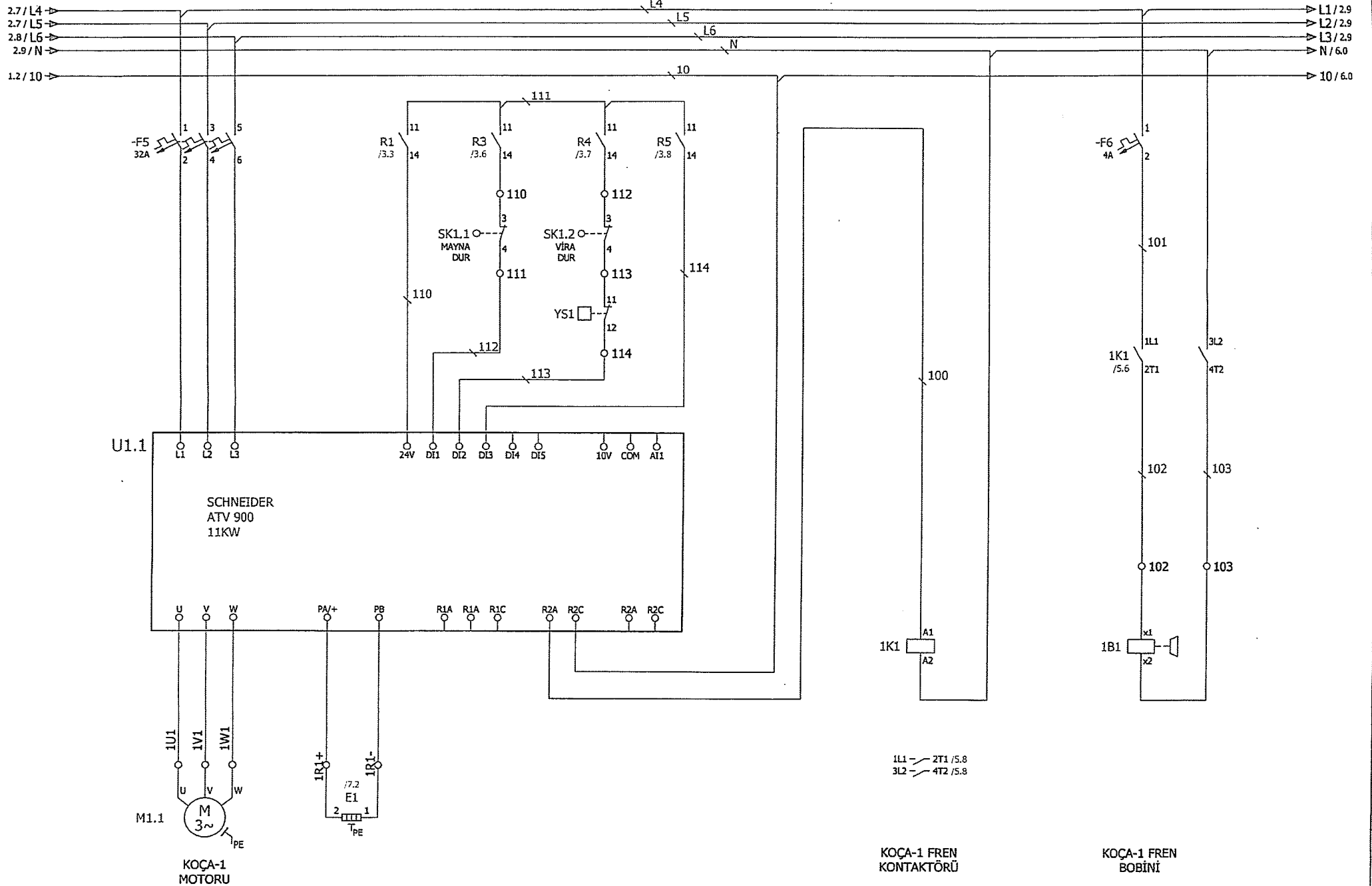

Date	29.03.2023				
Ed	IDRIS				
Appr					
Modification	Date	Name	Original	Replacement of	Replaced by

KEDİ-1 KOÇA GÜÇ VE KUMANDA

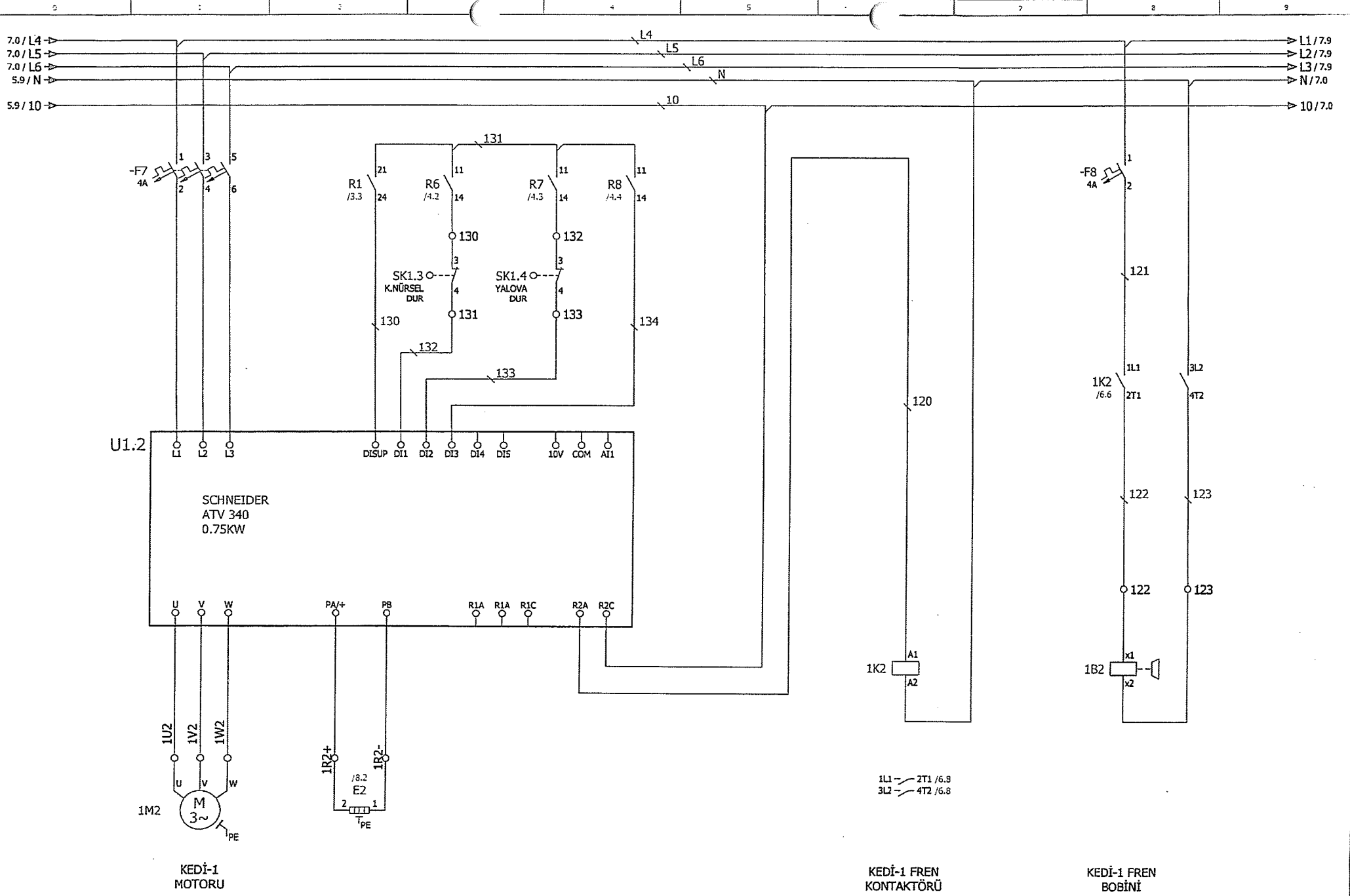

U1.2

KEDİ-1
MOTORU

KEDİ-1 FREN
KONTAKTÖRÜ

KEDİ-1 FREN
BOBİNİ

		Date	29.03.2023			KEDİ-1 KEDİ GÜÇ VE KUMANDA	=	
		Ed	IDRIS					+
		Appr						
Modification	Date	Name	Original	Replacement of	Replaced by		Page Page 6/	

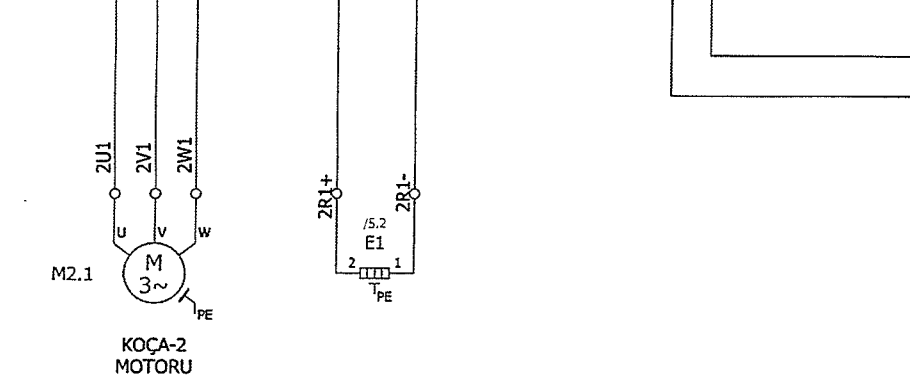
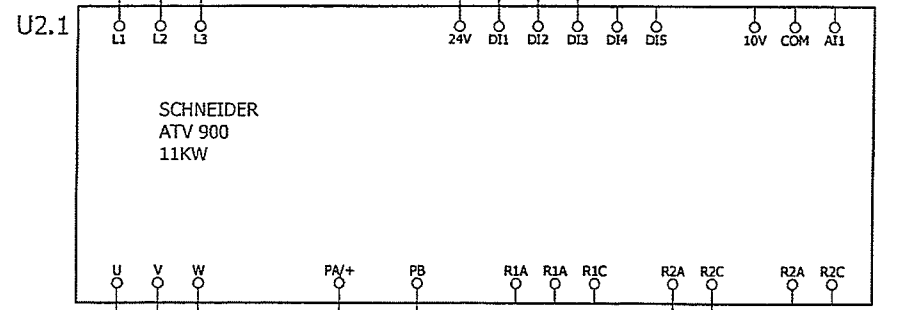
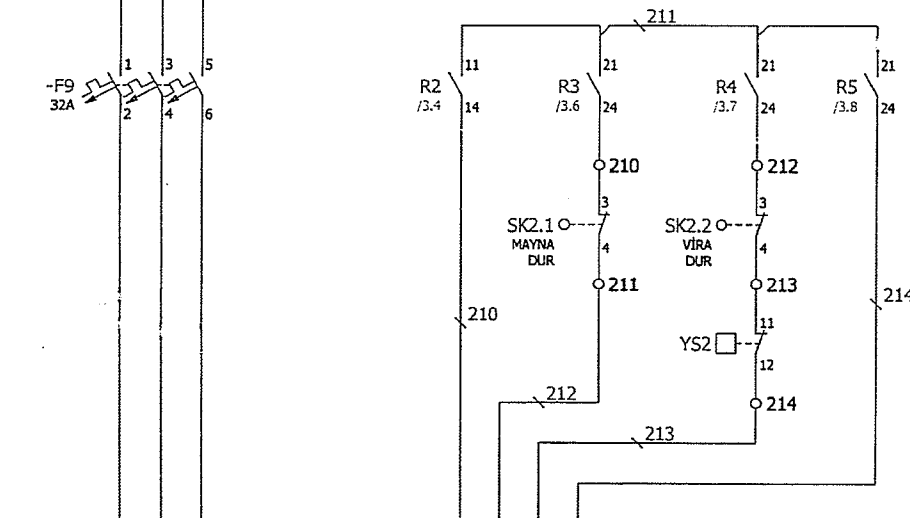
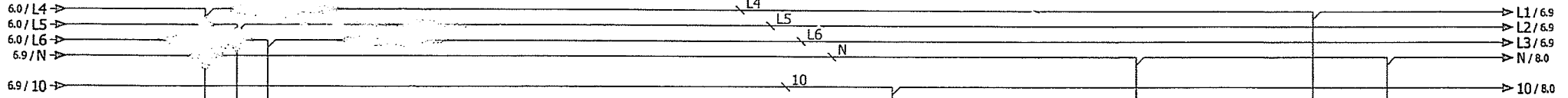

KOÇA-2 MOTORU

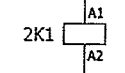
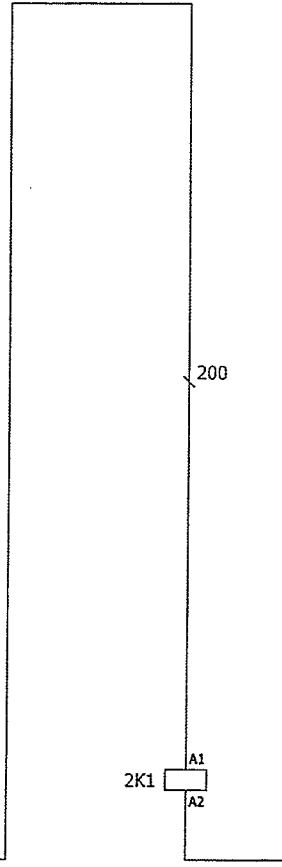

1L1 - 2T1 / 7.8
3L2 - 4T2 / 7.8

KOÇA-2 FREN KONTAKTÖRÜ

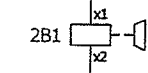
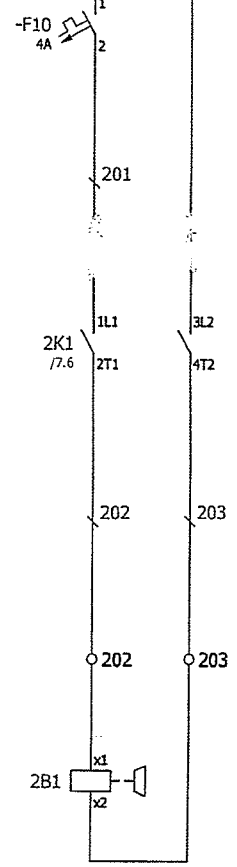

KOÇA-2 FREN BOBINİ

		Date	29.03.2023			KEDİ-2 KOÇA GÜÇ VE KUMANDA	=	
		Ed	IDRİS					+
		Appr						
Specification	Date	Name	Original	Replacement of	Replaced by		Page 7	
							Page 7/9	

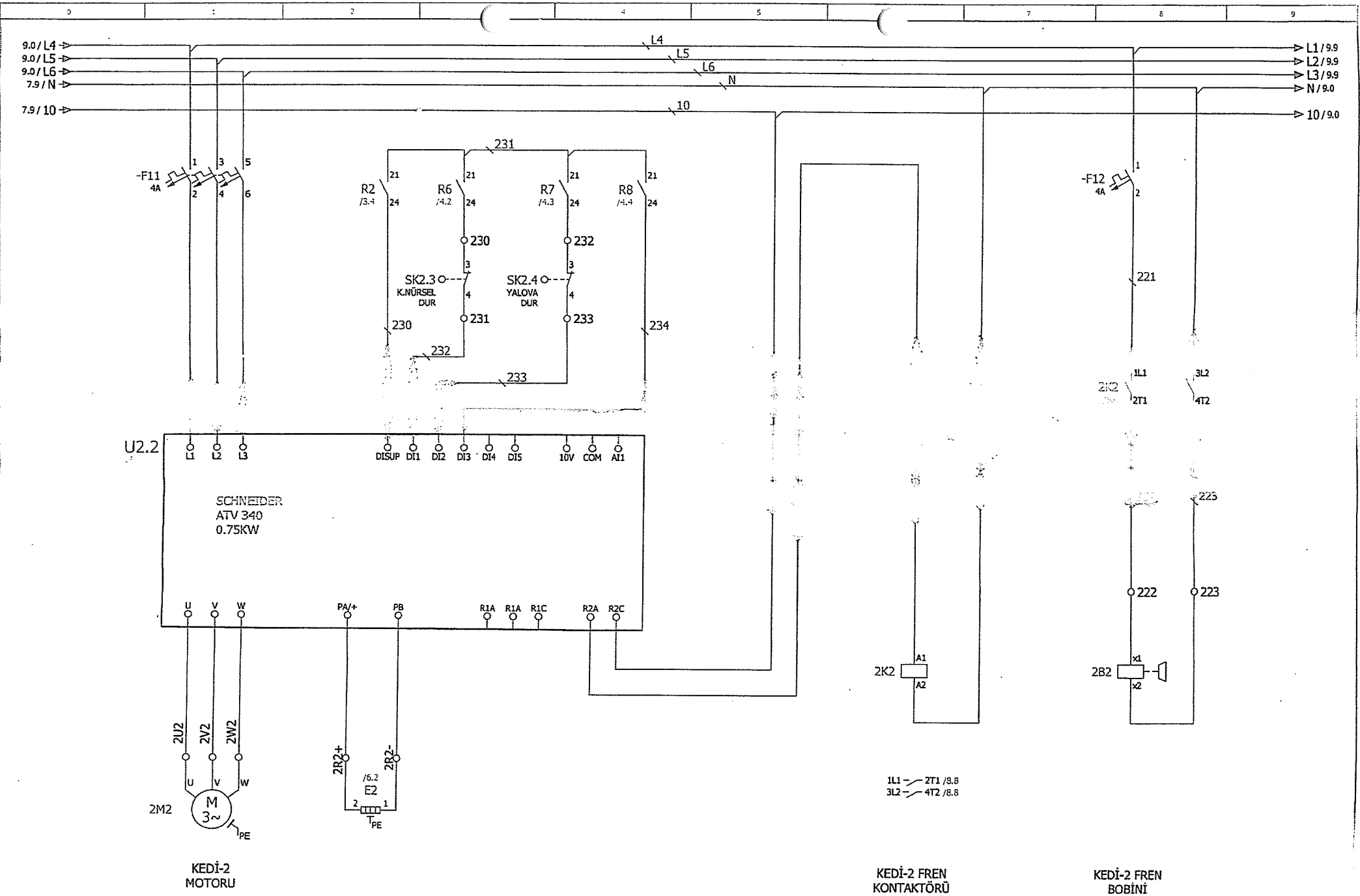

U2.2

SCHNEIDER
ATV 340
0.75KW

KEDİ-2
MOTORU

KEDİ-2 FREN
KONTAKTÖRÜ

KEDİ-2 FREN
BOBİNİ

7

Date 29.03.2023

Ed İDRİS

Appr

KEDİ-2 KEDİ GÜÇ VE KUMANDA

No	Date	Name	Original	Replacement of	Replaced by

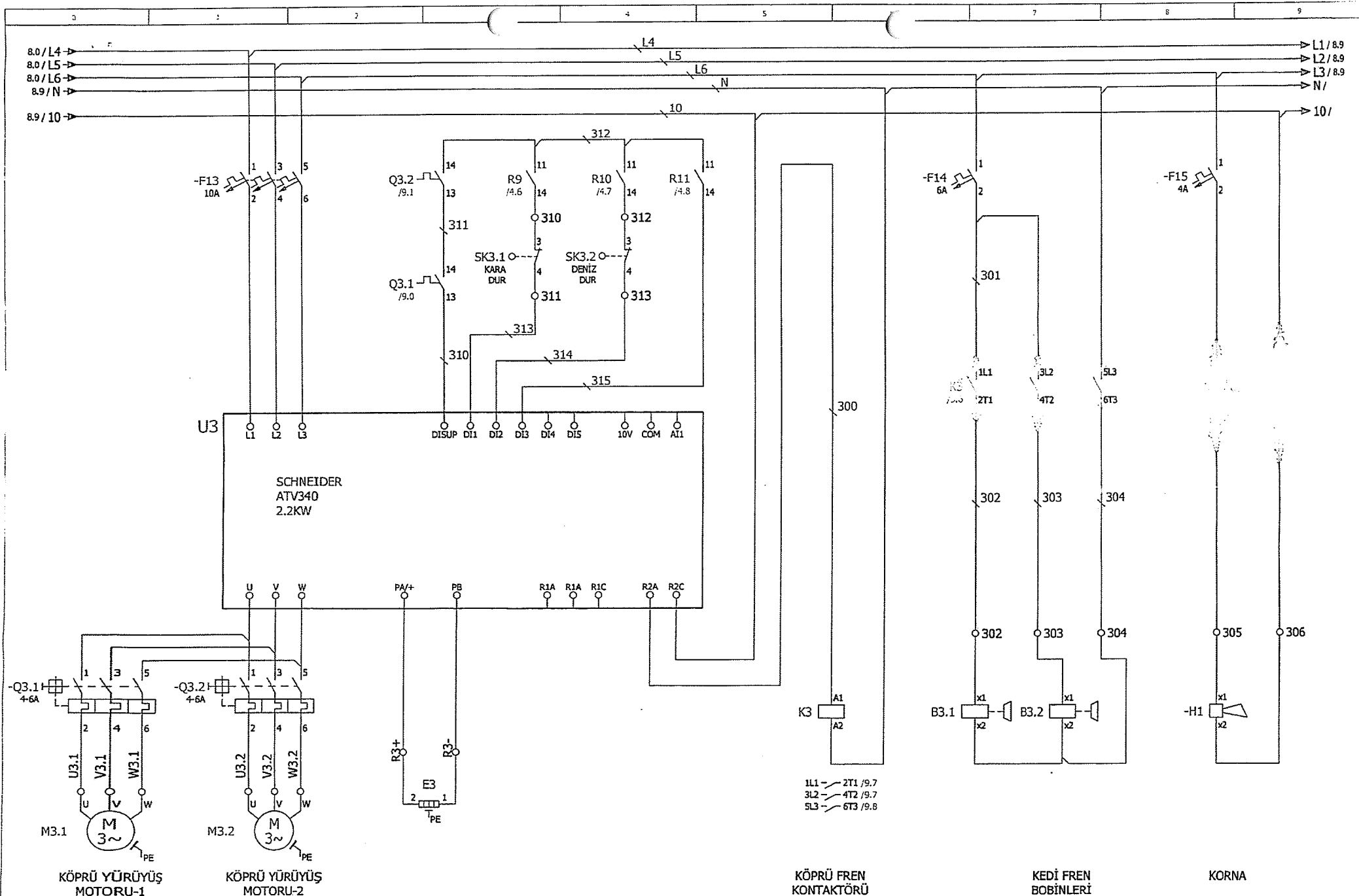

Date	29.03.2023	KÖPRÜ GÜÇ VE KUMANDA	=		
Ed	IDRIS			+	
Appr					
Revision	Date	Name	Original	Replacement of	Replaced by